

COAXIAL & TRIAXIAL CONNECTORS FOR BROADCASTING 3T SERIES



3T Series (75 Ω) for TV camera applications

Particularly intended for outdoor use, the product range of coaxial and triaxial connector of the 3T Series guarantees a protection index of IP66 as per IEC 60529 standard (mated connectors).

The 3T Series models are fully intermatable with the ULC Series size III C75 (coaxial 75 Ω) and size III TCX75 (triaxial 75 Ω).

Technical Characteristics

Characteristics	Coax	Triax	Standard
Impedance	75 Ω	75 Ω	–
Operating frequency	1.9 GHz	1.2 GHz	–
VSWR (f= GHz)	1.03 + 0.09f	1.02 + 0.15f	IEC 60169-1-1
Contact resistance	< 2.5 m Ω	< 2.5 m Ω	IEC 60512-2
Contact resis. internal screen	–	< 1.2 m Ω	–
Insulation resistance	> 10 ¹² Ω	> 10 ¹² Ω	IEC 60512-2
Watertightness	IP66	IP66	IEC 60529

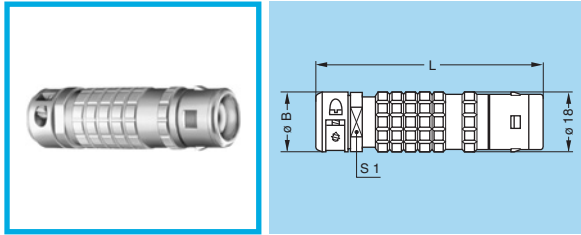
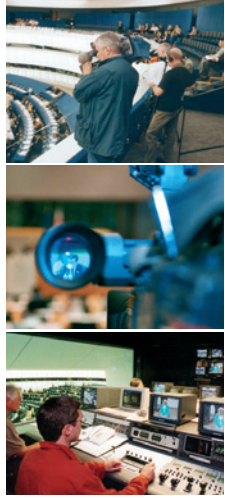

Note: Chrome-plated brass outer shell, PTFE insulator, solder male contact, cable clamping, soldered external shield (part number ending with «S»).

Recommended cables

Reference	Type	Imp. (Ω)	Cable groupe		
RG.11A/U	RG.144/U	RG.216/U	Coax	75±3Ω	5
Belden	7784A	Triax	75±3Ω	4	
Belden	7785A	Triax	75±3Ω	3	
Belden	9192-9232	Triax	75±3Ω	2	
Belden	9267	Triax	75±3Ω	1	
NEK	63990	Triax	75±3Ω	4	
DRAKA	Triax 8	Triax	75±3Ω	1	
DRAKA	Triax 11	Triax	75±3Ω	4	
DRAKA	Triax 14	Triax	75±3Ω	3	
Triax	Type A2	Triax	75±3Ω	1	
Triax	Type B2	Triax	75±3Ω	2	
Triax	Type C2	Triax	75±3Ω	6	

FFA Straight plug with cable clamping

Part Number	Type	B	L	S1	Cable groupe
FFA.3T.275.CTAY11	Coax	20	71	18	5
FFA.3T.675.CTAY92S	Triax	20	69	18	1
FFA.3T.675.CTAY11S	Triax	20	69	18	4
FFA.3T.675.CTAY13S	Triax	28	88	26	2
FFA.3T.675.CTAY14S	Triax	28	88	26	3
FFA.3T.675.CTAY17S	Triax	28	88	26	6

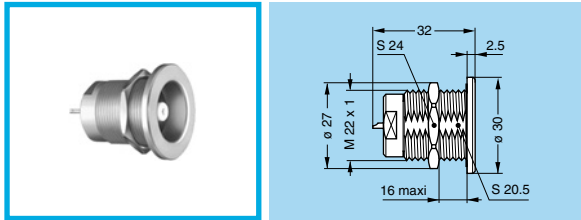

ERA Fixed socket, nut fixing

Part Number	Type	Weight (g)
ERA.3T.275.CTL	Coax	43.5
ERA.3T.675.CTL	Triax	46.0

Note: Chrome-plated brass outer shell, PTFE insulator, solder female contact.

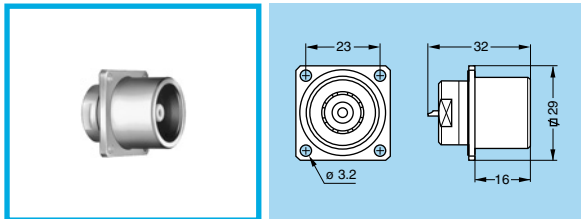

EBC Fixed socket with square flange, visible shell, screw fixing

Part Number	Type	Weight (g)
EBC.3T.275.CTL	Coax	55.5
EBC.3T.675.CTL	Triax	58.0

Note: Chrome-plated brass outer shell, PTFE insulator, solder female contact.

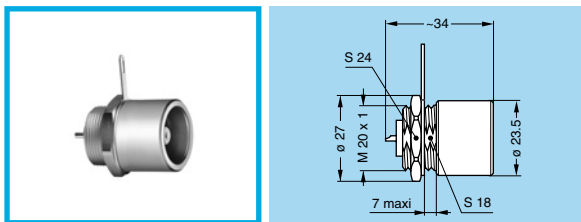

EHP Fixed socket, nut fixing, visible shell

Part Number	Type	Weight (g)
EHP.3T.675.CTL	Triax	51.0

Note: Chrome-plated brass outer shell, PTFE insulator, solder female contact.

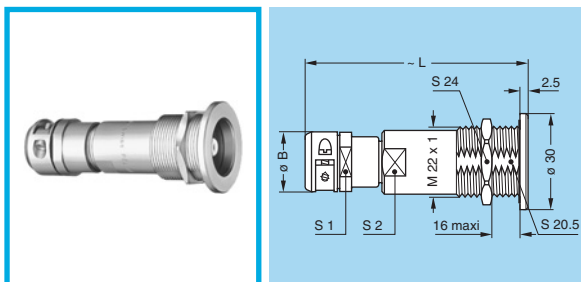

PSA Fixed socket with cable clamping, nut fixing

Part Number	Type	B	L	S1	S2	Cable groupe
PSA.3T.275.CTLY11	Coax	20	81	18	16	5
PSA.3T.675.CTLY92S	Triax	20	74	18	16	1
PSA.3T.675.CTLY11S	Triax	20	74	18	16	4
PSA.3T.675.CTLY13S	Triax	28	95	26	16	2
PSA.3T.675.CTLY14S	Triax	28	95	26	16	3
PSA.3T.675.CTLY17S	Triax	28	95	26	16	6

Note: Chrome-plated brass outer shell, PTFE insulator, solder female contact, cable clamping, soldered external shield (part number ending with «S»).

Note: all dimensions are in millimetres.

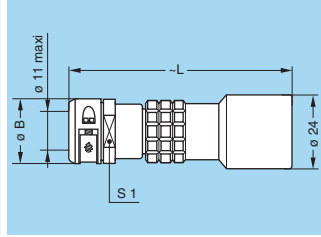

PCA Free socket with cable clamping

Part Number	Type	B	L	S1	Cable groupe
PCA.3T.675.CTLY92S	Triax	20	76	18	1
PCA.3T.675.CTLY11S	Triax	20	76	18	4
PCA.3T.675.CTLY13S	Triax	28	87	26	2

Note: Chrome-plated brass outer shell, PTFE insulator, solder female contact, cable clamping, soldered external shield (part number ending with «S»).

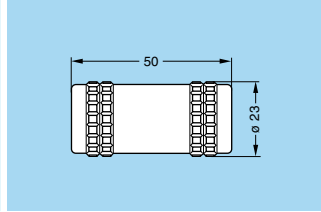

RMA Free coupler

Part Number	Type	Weight (g)
RMA.3T.275.CTM	Coax	76.0
RMA.3T.675.CTM	Triax	79.0

Note: Chrome-plated brass outer shell, PTFE insulator, female-female contact (for mating 2 FFA plugs).

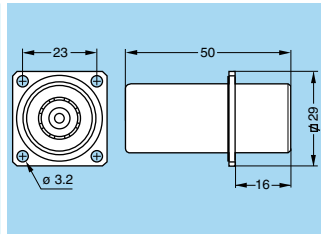
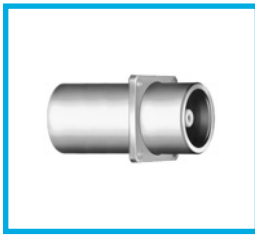

RBR Fixed coupler with square flange, screw fixing

Part Number	Type	Weight (g)
RBR.3T.275.CTM	Coax	83.0
RBR.3T.675.CTM	Triax	86.0

Note: Chrome-plated brass outer shell, PTFE insulator, female-female contact (for mating 2 FFA plugs).

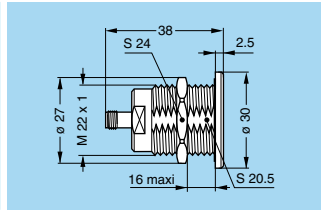
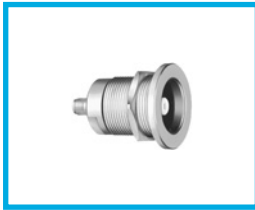

ASA Adapter, nut fixing, consisting of a LEMO socket and a coax SMA socket

Part Number	Type	Weight (g)
ASA.3T.275.CTM	Coax	51.0

Note: Chrome-plated brass outer shell, PTFE insulator, solder female contact.

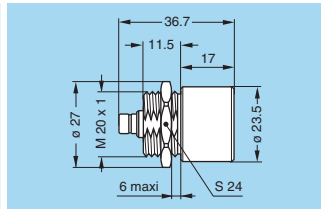

AZA Adapter, nut fixing, consisting of a LEMO socket and a triax SMZ socket

Part Number	Type	Weight (g)
AZA.3T.675.CTL	Triax	53.0

Note: Chrome-plated brass outer shell, PTFE insulator, solder female contact.

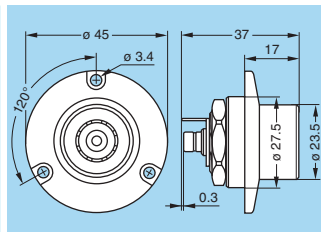
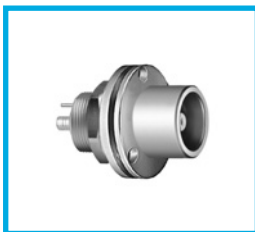

AZB Adapter, screw fixing, consisting of a LEMO socket and a triax SMZ socket

Part Number	Type	Weight (g)
AZB.3T.675.CTL	Triax	100.0

Note: Chrome-plated brass outer shell, PTFE insulator, solder female contact.

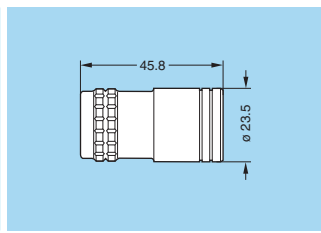
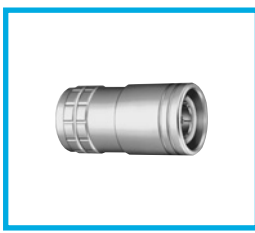

FWZ Adapter, consisting of a LEMO socket and a REDEL F T75 socket

Part Number	Weight (g)
FWZ.T75.FTS	76.0

Note: Chrome-plated brass outer shell, PTFE insulator, solder female contact.

All dimensions are in millimetres.

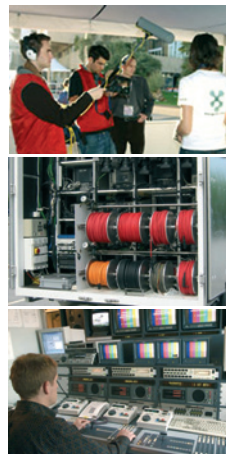

Accessories

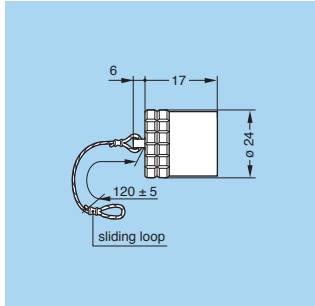

BFA Plug cap

Part Number	For model	Weight (g)
BFA.3T.100.NAS	FFA	27.0

Note:
 Body material: Nickel-plated brass (Ni 3µm)
 Lanyard material: Stainless steel
 Crimp ferrule material: Nickel-plated brass + polyolefin

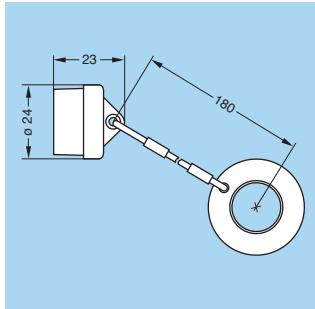

BFA Plug cap

Part Number	For model	Weight (g)
BFA.3T.100.PCZN	FFA	13.0

Note:
 Body material: Black EPDM
 Cord material: Black polyester
 Crimp ferrule material: Nickel-plated brass

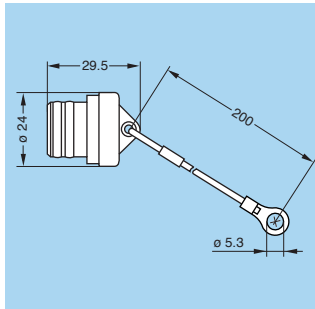

BRA Blanking cap for fixed sockets

Part Number	For models	Weight (g)
BRA.3T.200.PCZN	ERA, EBC, EHP, PSA, RBR, ASA, AZA, AZB	10.0

Note:
 Body material: Black EPDM
 Cord material: Black polyester
 Crimp ferrule material: Stainless steel AISI 304

Cable stripping lengths

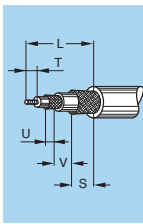

Cable group	Cable stripping lengths (mm)				
	L	S	T	U	V
1	30.0	7.5	11.5	7.0	4
2	41.0	8.0	11.5	7.5	14
3	41.5	8.0	12.0	3.5	18
4	33.5	11.0	11.5	7.0	4
5	26.5	4.5	11.5	6.5	4
6	41.5	8.0	12.0	3.5	18

Note: all dimensions are in millimetres.

Panel cut-outs

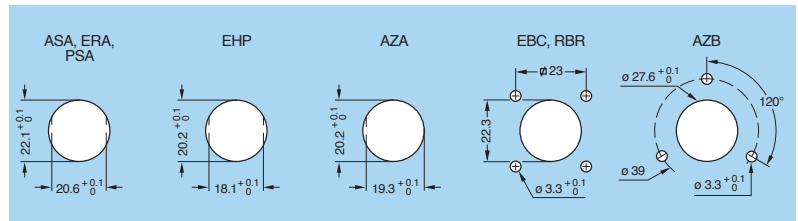

LEMO HEADQUARTERS

SWITZERLAND
 LEMO SA
 Chemin des Champs-Courbes 28 - P.O. Box 194 - CH-1024 Ecublens
 Tel. (+41 21) 695 16 00 - Fax (+41 21) 695 16 02 - e-mail: info@lemo.com

www.lemo.com